



Electrolux
PROFESSIONAL

**Beverage Dispensing System
Hot Chocolate Dispenser, 3 L,
black**

ITEM # _____

MODEL # _____

NAME # _____

SIS # _____

AIA # _____



560018 (LOLA3)

Hot Chocolate Dispenser
with 3 l bowl

Short Form Specification

Item No. _____

3lt hot chocolate dispenser; compact design. Transparent and extractable bowl that can be easily put in the fridge during the night. The vertical tap is easy to clean and to disassemble.

Main Features

- Hot chocolate dispenser ideal also for small places thanks to its compact design.
- Transparent and extractable bowl that can be easily put in the fridge during the night.
- The vertical tap is easy to clean and to disassemble.

APPROVAL: _____



Experience the Excellence
www.electroluxprofessional.com

Front

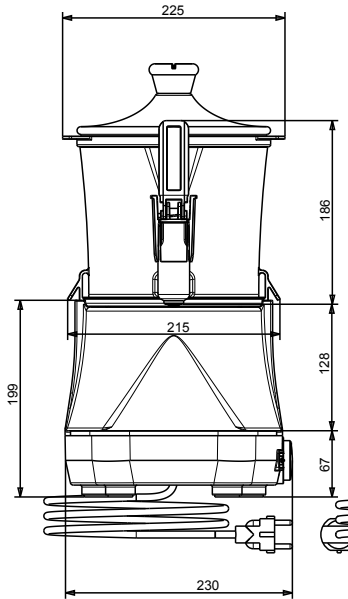

Side

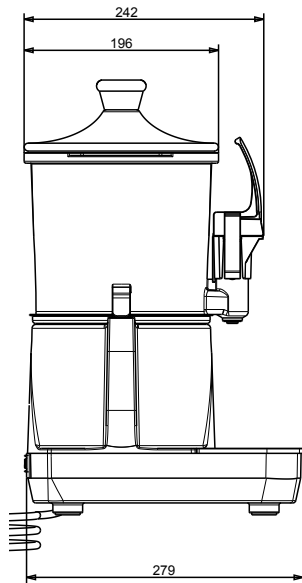

Top

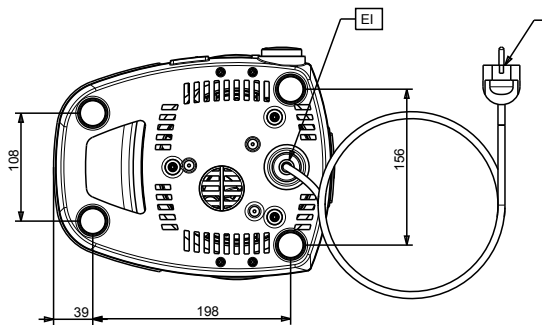

Electric

Supply voltage:
560018 (LOLA3) 220-240 V/1 ph/50 Hz
Electrical power max.: 0.85 kW

Key Information:

External dimensions,
Width: 233 mm
External dimensions,
Depth: 281 mm
External dimensions,
Height: 436 mm
Net weight: 5.2 kg
Shipping weight: 7 kg
Shipping height: 490 mm
Shipping width: 320 mm
Shipping depth: 360 mm
Shipping volume: 0.06 m³